

Pl. No. 947750

8/87

OPERATING
INSTRUCTIONS
for
AMPROBE®
Hand-Cranked
MEGOHMMETER
Model AMC-2
Model AMC-3
Model AMC-4

See Precautions for Personal and
Instrument Protection on Page 4

See Limited Warranty on Page 2

 **AMPROBE INSTRUMENT®**
DIVISION OF CORE INDUSTRIES INC., LYNBROOK, NEW YORK 11563

LIMITED WARRANTY

Congratulations! You are now the owner of an AMPROBE® instrument. It has been quality crafted according to quality standards and contains quality components and workmanship. This instrument has been inspected for proper operation of all of its functions. It has been tested by qualified factory technicians according to the long-established standards of AMPROBE INSTRUMENT.

Your AMPROBE instrument has a limited warranty against defective materials and/or workmanship for one year from the date of purchase provided that, in the opinion of the factory, the instrument has not been tampered with or taken apart.

Should your instrument fail due to defective materials, and/or workmanship during the one-year warranty period, return it along with a copy of your dated bill of sale which must identify instrument by model number and serial number.

For your protection, please use the instrument as soon as possible. If damaged, or should the need arise to return your instrument, it must be securely wrapped (to prevent damage in transit) and sent prepaid via Air Parcel Post insured or UPS where available to:

Service Division
AMPROBE INSTRUMENT
630 Merrick Road (For U.P.S.)
P.O. Box 329 (For P.P.)
Lynbrook, NY 11563-0329

Outside the U.S.A. the local Amprobe representative will assist you. Above limited warranty covers repair and replacement of instrument only and no other obligation is stated or implied.

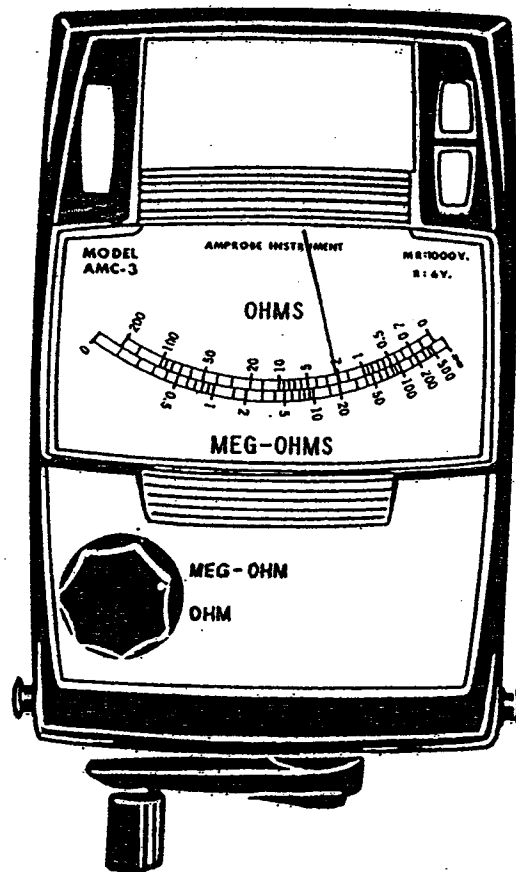

PRECAUTIONS FOR PERSONAL AND INSTRUMENT PROTECTION

Although there is high voltage at the tips of the test leads when the AMC-2/3/4 is used as a megohmmeter, low current flow reduces any danger to relatively safe levels. However, contact with the probe tips while the instrument is energized should be avoided.

DO NOT USE IN AN EXPLOSIVE ATMOSPHERE.

If the equipment to be tested was in use up to the time of testing, it will most likely have a capacitive charge built up. This capacitance must be discharged before making any resistance measurements. This can be accomplished as follows:

1. Plug test leads into instrument.
2. Connect "LINE" test lead to equipment to be tested.
3. Touch the "EARTH" test lead to the same point on the equipment that the "LINE" test lead is connected to.
4. If the equipment has multiple windings, this should be done with each winding individually.

Equipment under test with the megohmmeter may build up a capacitive charge from the testing. With the AMC-2/3/4, you can (1) wait a few minutes for the charge to dissipate or (2) remove the test lead from the EARTH jack on the tester and touch to the equipment terminal that the other test lead (LINE) is connected to. See Figure 1.

Before connecting the AMC-2/3/4 to any circuit as either an ohmmeter or megohmmeter check for any voltage. Do not connect the AMC-2/3/4 ohmmeter or megohmmeter to a live circuit.

Always store the instrument in its carrying case.

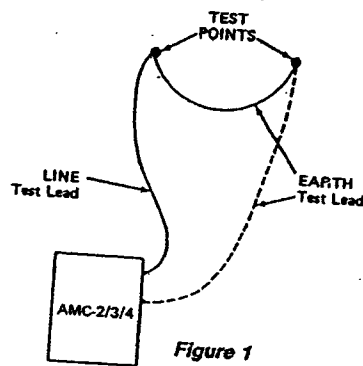

Figure 1

SPECIFICATIONS
Model AMC-2/AMC-3/AMC-4

MODEL	RANGES	TEST VOLTAGE	ACCURACY
AMC-2	0-100 MΩ (1MΩ midscale)	500VDC	±5% of reading from .1 to 50MΩ
	0-200 ohms (10Ω midscale)	6VDC	±10% of reading at all other points
AMC-3	0-500 MΩ (5MΩ midscale)	1000VDC	±5% of reading from .5 to 200MΩ
	0-200 ohms (10Ω midscale)	6VDC	±10% of reading at all other points
AMC-4	0-100 MΩ (3MΩ midscale)	500VDC	±5% of reading from .1 to 50MΩ
	0-500 MΩ (6MΩ midscale)	1000VDC	±10% of reading at all other points
	0-200 ohms (10Ω midscale)	6VDC	±5% of reading from .5 to 100MΩ ±10% of reading at all other points

Size: 4" × 3.625" × 7"
 (101.6mm × 92.1mm × 177.8mm)

Weight: 2 lbs. 8 oz. (1.13Kg)

OPERATING INSTRUCTIONS

IMPORTANT: See Precautions for Personal and Instrument Protection before proceeding.

Note: Pointer is free-floating until crank is rotated.

1. To use as a megohmmeter or an ohmmeter, disconnect the device or circuit to be tested from the line.
2. Set range switch to appropriate range — "MEG-OHM"* for insulation resistance testing and other high resistance measurements; "OHM" for continuity checks and low resistance measurements.
3. Select a pair of test leads (one probe and one clip type or two clip type) that best fits your application.
4. Depress button over the EARTH jack and insert the black lead. Depress button over the LINE jack and insert red lead.
5. Connect test leads to device or circuit to be tested.
6. Place instrument on a firm and level surface.
7. Turn crank handle in a clockwise direction at a speed that causes the crank to free-wheel.
8. Take reading on scale corresponding to range switch position.

*On AMC-4, "1000V/500M Ω " or "500V/100M Ω "

GUARD TERMINAL

There are two possible conducting or leakage paths in the insulation of all electrical apparatus — one through the insulating material and the other over its surface. By using the Guard Terminal the surface leakage can be separated and a direct measurement made of the insulation itself. See Fig. 2 for a typical use of the Guard Terminal.

Why Insulation Resistance Testing?

The primary purpose of insulation is to keep electricity flowing in the desired path. The "perfect" insulation would have infinite resistance which would prevent the flow of any current through the insulation to ground. However, there isn't any "perfect" insulation material so there is always some current flow. Good insulation is one that has and keeps a high resistance value in order to minimize the current flow.

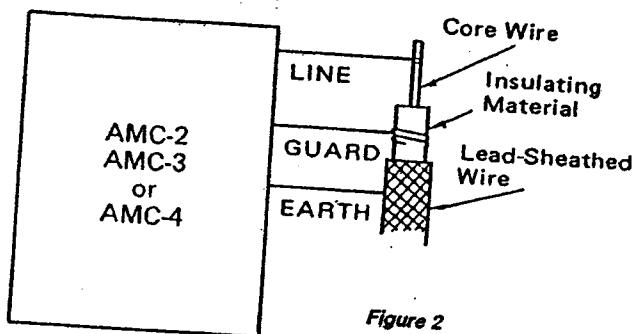

Figure 2

Unless there is accidental damage of some sort, insulation failure is generally gradual rather than sudden. This is because failure is generally a wearing down process due to repeated heating and cooling, the related expansion and contraction, dirt, physical abrasion, vibration, moisture and chemicals.

When insulation starts to fail, its resistance decreases allowing more current to flow through the insulation. If the resistance continues to decrease, the condition of the insulation may reach a point where it may permit a large enough current flow through the insulation to cause 1) a simple blowing of a fuse, 2) equipment damage, or 3) even fatal shock. That's why, if you're responsible for the servicing, maintenance or installation of electrical equipment, you must be concerned about insulation resistance!

An Insulation Resistance Testing Program helps reveal failing insulation before it becomes a serious problem. Such a testing program consists of periodic insulation resistance tests on critical equipment and systems. The results are recorded on a control card or file for each piece of equipment or each test point in a system. Any trend that indicates a decreasing insulation resistance value is an indication that the insulation is failing and that corrective maintenance should be scheduled.

MEASURING INSULATION RESISTANCE

Without going into a great deal of technical explanation, let us state that insulation resistance measurements are affected by a number of factors. Temperature and the duration of the measurement are two primary ones. Humidity may also affect readings so it is a good idea to make a note as to whether the air is dry or humid at the time of the measurement. You may find that insulation resistance readings are lower on humid days and higher on dry days. Wet or flooded equipment should be dried and cleaned as much as possible before measurements are taken. Lastly, dirt or other contaminants (corrosion, chemicals, etc.) can also affect readings, either raising or lowering them. Therefore, steps should be taken to make certain that the contact points at which measurements are to be taken are reasonably clean.

TEMPERATURE

Insulation resistance can vary significantly with temperature. If your periodic insulation resistance measurements can not be taken at the same temperature, it is important that resistance measurements be adjusted to a base temperature. From IEEE Std 43-1961 for Rotating Machinery. $R_{40c} = K_{40c} \times R_t$

where R_{40c} = insulation resistance (in megohms) corrected to 40°C

R_t = measured insulation resistance (in megohms) at t°C

K_{40c} = temperature coefficient of insulation resistance as observed for temperature t°C see Fig. 1

Example: An insulation has a resistance of 100 megohms at 30°C. From Fig. 3, K_{40c} is 0.5

$$R_{40c} = 0.5 \times 100 = 50 \text{ megohms}$$

For temperature correction factors for cable insulation, refer to specifications of the Insulated Power Cable Engineers Assn. and the Assn. of Edison Illuminating Companies.

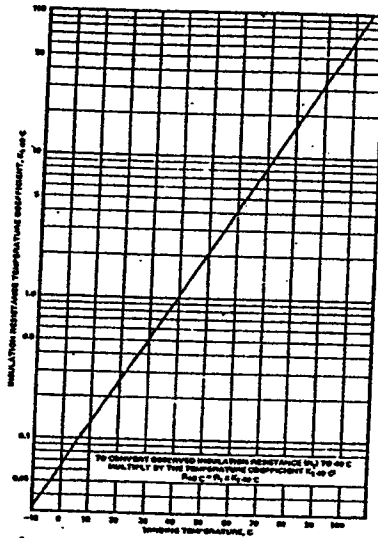

Approximate Temperature Coefficient
Insulation Resistance
Rotating Machine Armature Windings
Figure 3

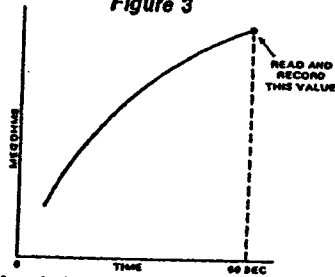

Typical curve of Insulation resistance (in megohms) versus time
Figure 4

TIME

The duration of the resistance measurement also affects the reading. If the insulation is good, the reading will continually increase as long as the megohmmeter is connected to the insulation. See Fig. 4. The most common megohmmeter measurement is taken at the end of a 60 second interval as this time period generally gives a satisfactory measurement of the insulation resistance.

A second type of test involves taking a reading after 30 seconds and 60 seconds. The 60-second reading divided by the 30-second reading is known as the Dielectric Absorption Ratio. Comparing periodic Dielectric Absorption Ratios may prove more useful than comparing one-minute readings. Generally speaking a ratio of 1.25 is the bottom limit for borderline insulation. An extension of this test is one that involves readings taken after 60 seconds and 10 minutes. The ratio of the 10 minute reading to the 60 second reading is referred to as the Polarization Index. The resistance measurement taken at the end of 10 minutes should be considerably higher than at 60 seconds. The measured insulation resistance of a dry winding in good condition should reach a relatively steady value in 10 minutes. If the winding is wet or dirty the steady value will usually be reached in one or two minutes. The Polarization Index is helpful in evaluating the winding dryness and fitness for over-potential testing.

For a fuller explanation of these ratios and safe values see *IEEE Std 43-1961 IEEE Standard Guide for Testing Insulation Resistance of Rotating Machinery

and

*IEEE Std 62-1958 Recommended Guide for Making Dielectric Measurements in the Field

*May be ordered from:

IEEE
445 Hoes Lane
Piscataway, New Jersey 08854

As a guide, the recommended minimum value of the Polarization Index for alternating current and direct-current rotating machines is 1.5 for 105C (Class A) insulation systems and 2.0 for 130C (Class B) insulation systems.

WHAT THE READINGS MEAN

As we have already pointed out, insulation resistance measurements are affected by temperature, humidity and the time duration of the measurement. They are also affected by such things as type of insulation, its thickness, cleanliness and even the design of the equipment. Therefore, to try and give specific values for each and every situation would represent an impossible job for this manual. However, there are some basic guide lines that are usable.

From the IEEE Std 43-1961 Standard Guide for Testing Insulation Resistance of Rotating Machinery:

$$R_m = K_v + 1$$

where

R_m = recommended minimum insulation resistance in megohms at 40°C of the entire machine winding

K_v = rated machine potential, in kilovolts

If winding is not at temperature of 40°C, temperature correction should be made. See page 8.

This essentially follows an old rule of thumb which set a minimum value of 1 megohm for every thousand volts of equipment rating.

For specific information about individual products, contact the manufacturer for specifications on insulation resistance values and test procedures.

The important thing to remember is that periodic testing is the primary method of picking up sudden decreases in insulation resistance and this is the key to detecting insulation that is failing. Because it is possible for insulation to fail between tests, testing should be scheduled based on the type of equipment. Generally speaking, equipment that involves movement (e.g. motors) should be checked more frequently than stationary equipment (e.g. cables). In addition, the more critical the equipment is to a company's operation, the more frequently it should be checked.

WHAT TO RECORD

So that your periodic insulation resistance measurements can be compared meaningfully, you must have certain information recorded. Each piece of equipment should have its own record card on file. Typical information that should be included:

- 1) Equipment description including rating and serial number.
- 2) Equipment location (department, floor, etc.)
- 3) Date of installation.
- 4) Dates of repairs and description.
- 5) Specific test points (e.g. motor frame and motor lead disconnected at motor junction box). In some cases a sketch might help another person performing the test at a later time.
- 6) Equipment temperature at time of reading.
- 7) Room (ambient) temperature at time of reading.
- 8) Relative Humidity measurement.
- 9) Correction factor used to adjust reading to base temperature.
- 10) The adjusted insulation resistance.

With this information, you can make meaningful comparisons between readings. See page 18 for a typical record card.

CONNECTING THE MEGOHMMETER

The basic purpose of an insulation resistance measurement is to test the insulation. Connections, therefore, must be made so that the test voltage is applied across or through the insulation. Within any system or piece of equipment, there may be more than one set of points that should be tested. The illustrations and related descriptions that follow will serve as a guide for testing the specific equipment shown. The approaches shown can also be used as guides for other similar equipment.

Note: Disconnect equipment or circuits to be tested from the power supply. Verify that equipment or circuit is de-energized by checking with a volt-meter. See Precautions for Personal and Instrument Protection on page 4.

POWER TOOLS AND SMALL APPLIANCES

This test would also apply to other similar equipment that has a line cord. For double-insulated power tools, the megohmmeter lead shown connected to the housing would be connected to some metal part of the tool (e.g. chuck, blade). See Fig. 5

Note: The switch of the device must be in the "ON" position.

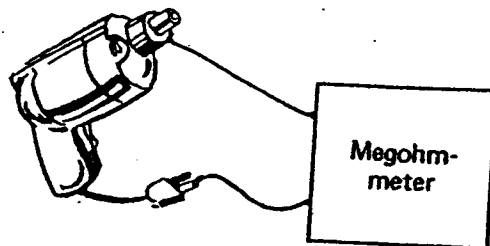

Figure 5

MOTORS

AC—Disconnect the motor from the line by disconnecting the wires at the motor terminals or by opening the main switch. If the main switch is used and the motor also has a starter then the starter must be held, by some means, in the "ON" position. In the latter case, the measured resistance will include the resistances of the motor, wire and all other components between the motor and the main switch. If a weakness is indicated, the motor and other components should be checked individually.

If the motor is disconnected at the motor terminals, connect one megohmmeter lead to the grounded motor housing and the other lead to one of the motor leads.

DC—Disconnect the motor from the line. To test the brush rigging, field coils and armature connect one megohmmeter lead to the grounded motor housing and the other lead to the brush on the commutator. If the resistance measurement indicates a weakness, raise the brushes off the commutator and separately test the armature, field coils and brush rigging by connecting one megohmmeter lead to each of them individually, leaving the other connected to the grounded motor housing. The above also applies to DC Generators.

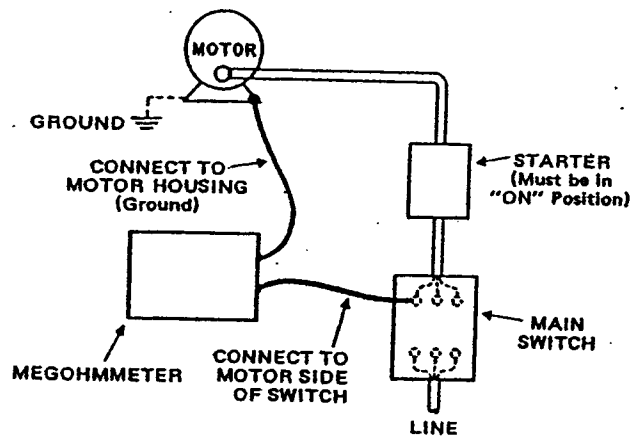

Figure 6

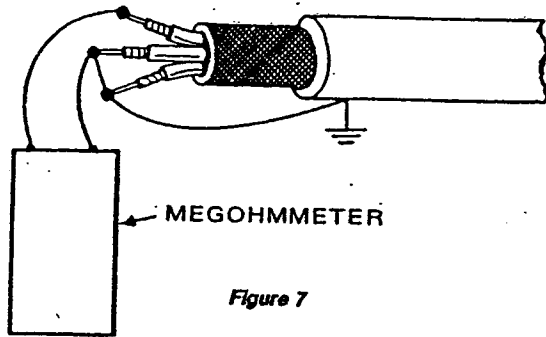

Figure 7

CABLES

Disconnect the cable from the line. Also disconnect opposite end to avoid errors due to leakage from other equipment. Check each conductor to ground and/or lead sheath by connecting one megohmmeter lead to a ground and/or lead sheath and the other megohmmeter lead to each of the conductors in turn. Check insulation resistance between conductors by connecting megohmmeter leads to conductors in pairs.

HERMETIC COMPRESSOR SYSTEMS

The following table may be used as a guide to determine the extent to which a system may have been contaminated by moisture.

<u>MEGOHM-METER READING</u>	<u>COMPRESSOR CONDITION</u>	<u>SUGGESTED PREVENTIVE MAINTENANCE</u>
100 Megohms to Infinity	Good	None necessary
50 to 100 Megohms	Moisture Present	Change drier
20 to 50 Megohms	Severe moisture and possible contaminated oil	Change numerous driers, change oil
0 to 20 Megohms	Severe contamination	Dump oil and entire refrigerant charge, evacuate system, install liquid and suction line driers, re-charge system with new oil and refrigerant

CIRCUIT BREAKERS AND SWITCHES

Disconnect from line. To test each terminal to ground, connect one megohmmeter lead to the frame or ground and connect the megohmmeter lead to each terminal, one after the other. To test between terminals, connect megohmmeter leads to pairs of terminals.

RELAYS AND COILS

Disconnect from line. To test coil, connect one megohmmeter lead to one of the coil leads and the other megohmmeter lead to ground. Then connect megohmmeter between one coil lead and core.

For relay, connect one megohmmeter lead to the relay contact and the other megohmmeter lead to the coil and core, one after the other.

SERVICE

Serial number is located on the label on the back of the instrument.

For Factory service, package instrument and packing slip with sufficient cushioning material in a shipping carton; make certain your name and address also appear on box as well as packing slip; ship prepaid via U.P.S. (where available) or Air Parcel Post insured to:

Service Division
AMPROBE INSTRUMENT
630 Merrick Road (Use for U.P.S.)
P.O. Box 329 (Use for Parcel Post)
Lynbrook, NY 11563-0329

Outside the U.S.A. the local Amprobe representative will assist you.

TEST RECORD - INSULATION RESISTANCE

EQUIPMENT DESCRIPTION _____ SERIAL NO. _____
 MFGR. _____ TYPE & MODEL _____ VOLTAGE _____ MP _____
 LOCATION _____ DATE INSTALLED _____
 REMARKS _____

DATE	MEGOMETER READING CHART		REMARKS
	100	10	
	100	10	
	80	8	
	60	6	
	40	4	
	20	2	
	10	1	
	5	.5	
	4	.4	
	3	.3	
	2	.2	
	1	.1	
	ZERO		

